

## Top Drive Shaft E-22 Montageanleitung / Installation Manual

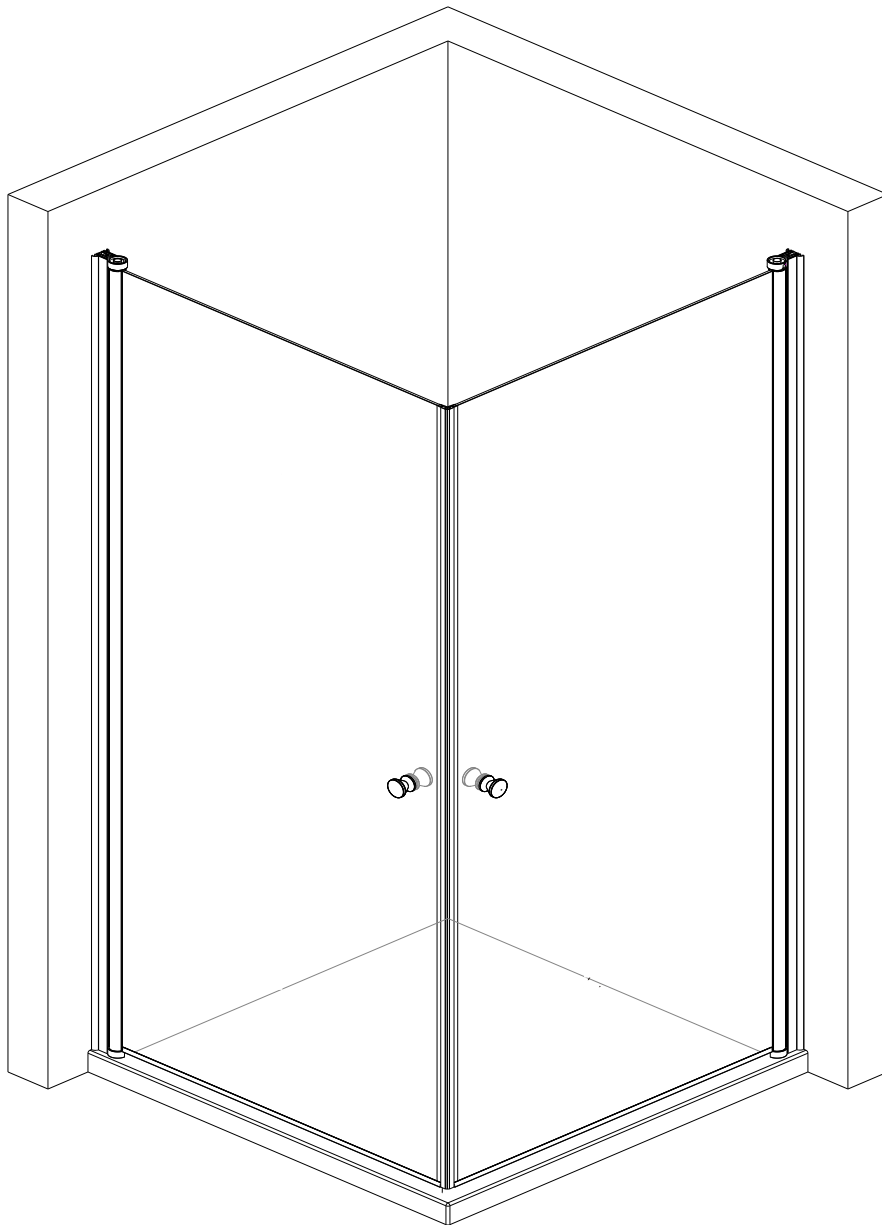

## Beachtung /Attention

Vor Montage Produkt auf Schäden und Vollständigkeit prüfen.

Schäden, die durch die Montage von Produkten entstehen, die erkennbar unvollständig oder fehlerhaft sind, werden nicht akzeptiert.

Bitte Einbausituation auf lotrechten oder waagrechten und ebenen Zustand prüfen und der Wand entsprechende Befestigungen verwenden.

Auf der Garantiekarte finden Sie die Garantienummer. Damit können Sie Garantiefälle abwickeln und 10 Jahre lang Ersatzteile nachkaufen. Bitte nicht entfernen. Für Rückfragen stehen wir unter der auf der Karte angegebenen Adresse zur Verfügung.

Before assembly, check the product for damage and completeness.

Damage caused by assembling products that are recognisably incomplete or faulty will not be accepted.

Please check that the mounting location is perpendicular or horizontal and level and use fixing devices that are suitable for the wall.

You will find the warranty number in the warranty card. This will allow you to pursue warranty claims and to purchase replacement parts for ten years. Please do not remove it. Should you have any queries, we can be contacted at the address given on the card.

Benötigte Werkzeuge (nicht enthalten) / Necessary tools (not included)

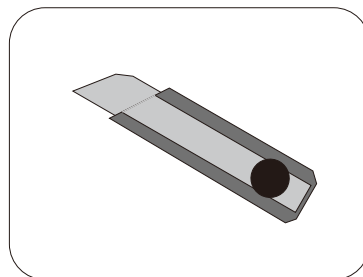
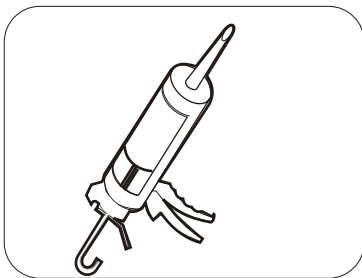
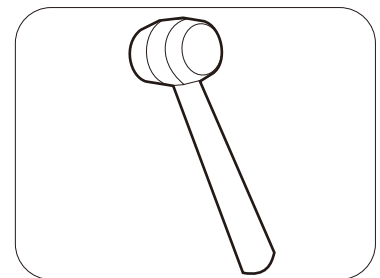
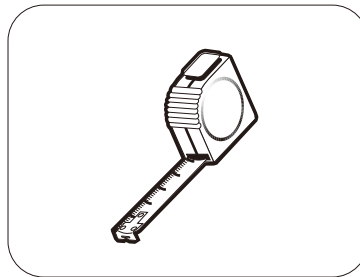
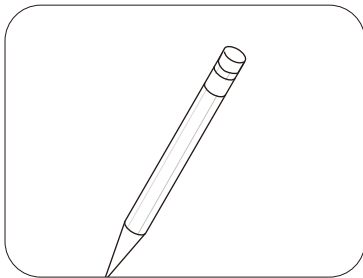
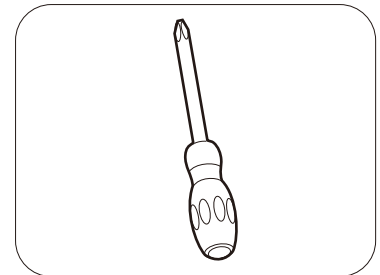
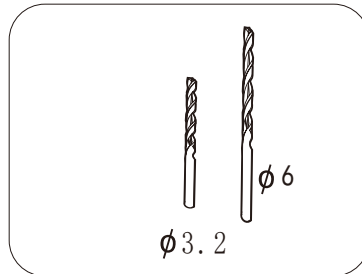
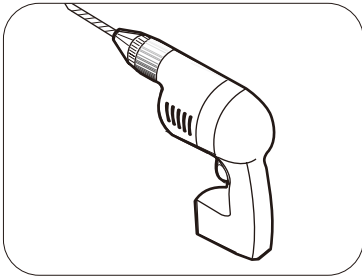

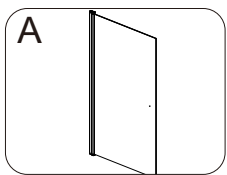
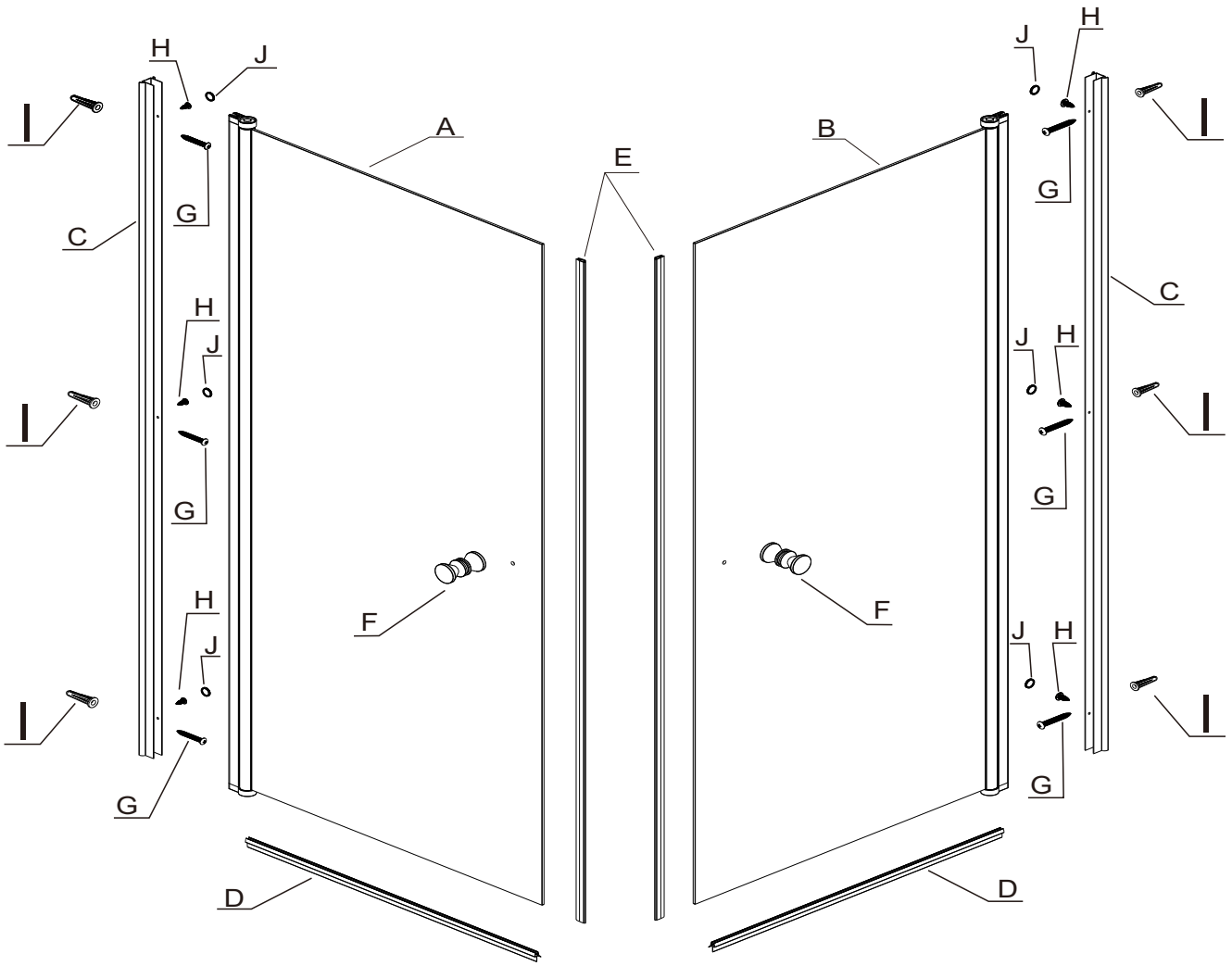

x1

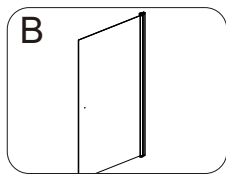

x1

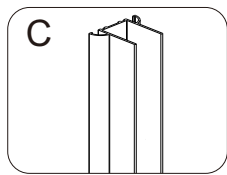

x2

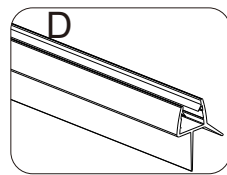

x2

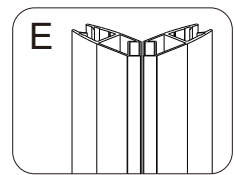

x1

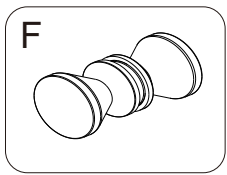

x2

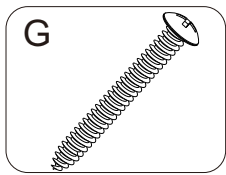

x6

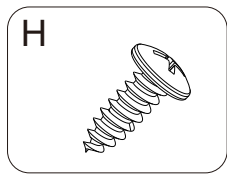

x6

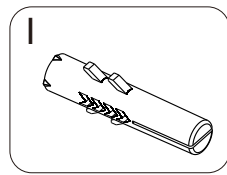

x6

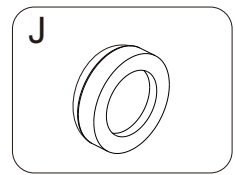

x6

material indicate installation material.

Montageschritten indicate installation sequence.

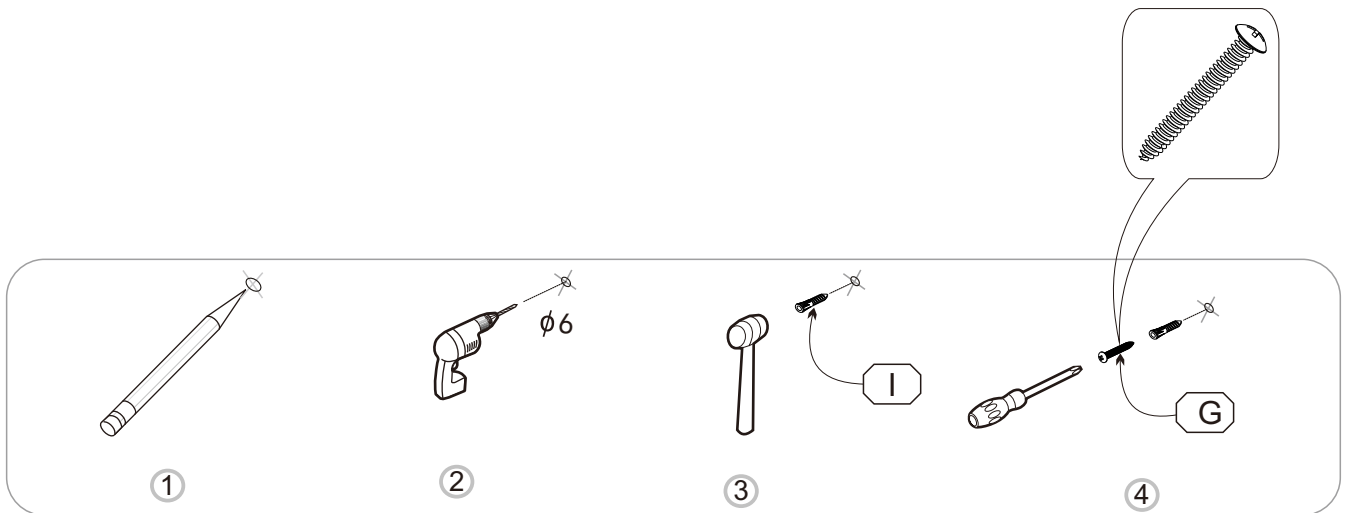
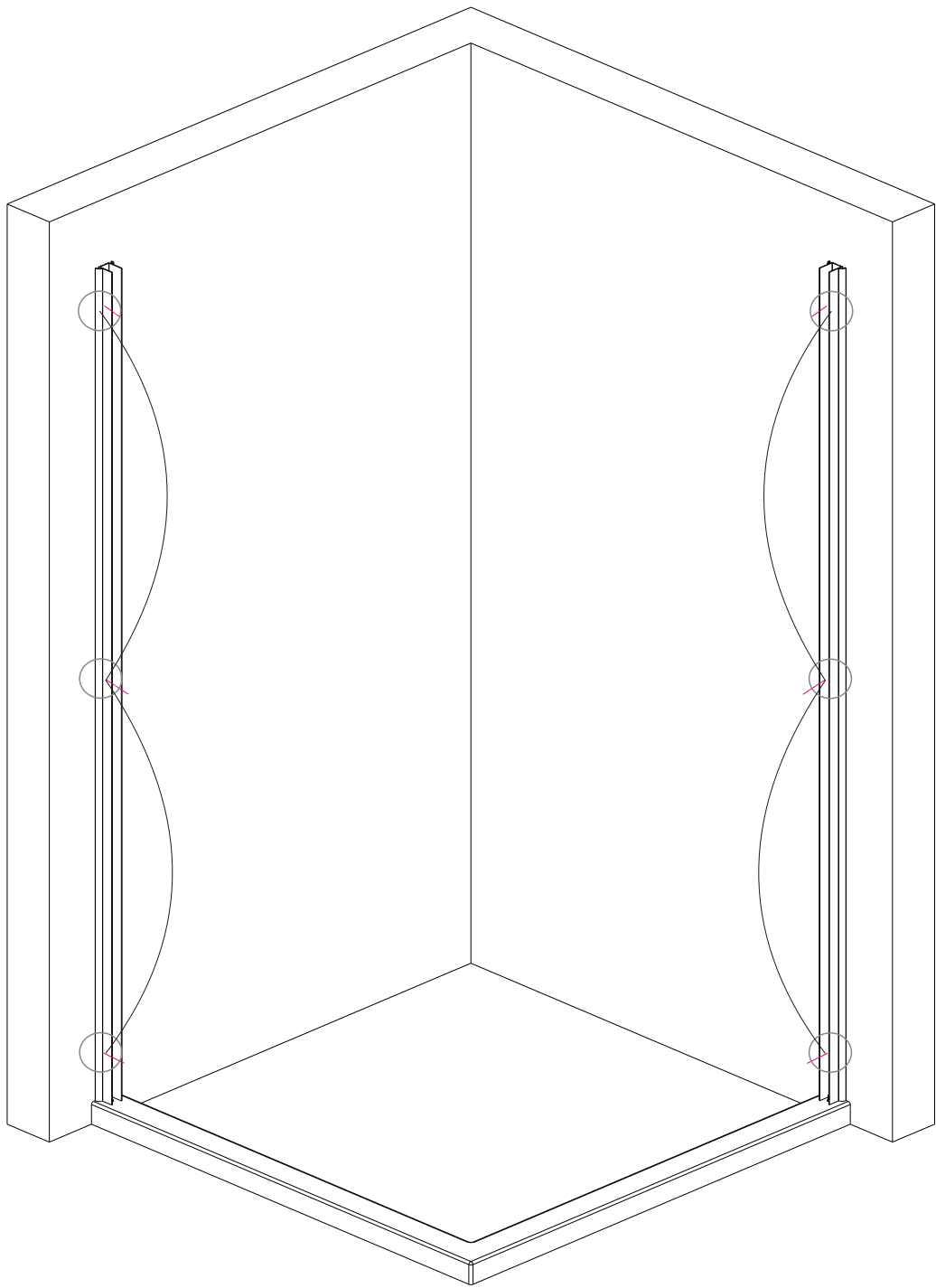

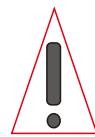
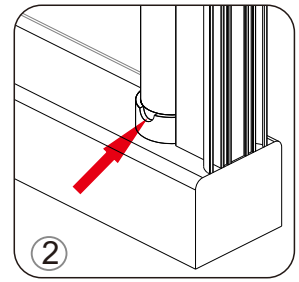
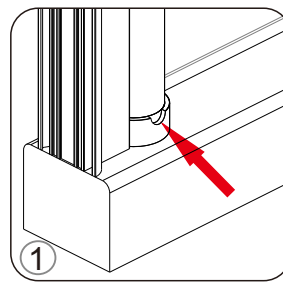
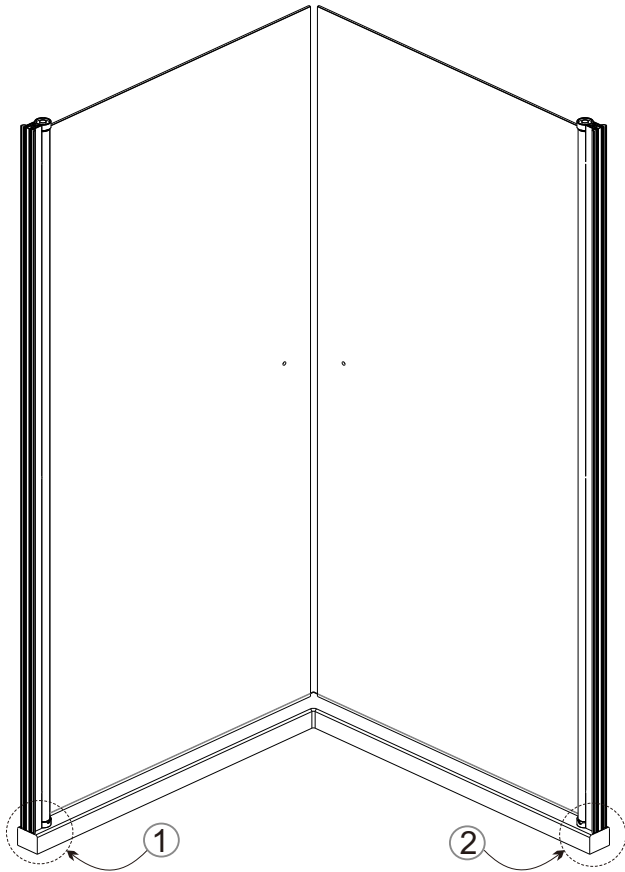

Bitte beachten: An der Drehbasis gibt es eine Lücke, bei Montage bitte die Lücke nach unten und nach innen platzieren

